



en zh



Wiser by SE app



E8331SCN200ZB\_WE  
E8331SCN200ZB\_WG

AvatarOn

Schneider Electric



Works with Wiser Hub CCT501900. Refer to system user guide for more information.  
[https://download.schneider-electric.com/files?p\\_Doc\\_Ref=MFR1569800](https://download.schneider-electric.com/files?p_Doc_Ref=MFR1569800)



Operating Voltage: 220 VAC to 240 VAC

200 W, Power Factor = 0.6

Operating Voltage: 100 VAC to 120 VAC

100 W, Power Factor = 0.6

Operating Voltage: 48 VDC

40 W

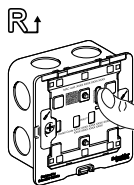
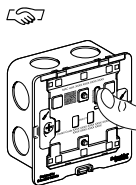
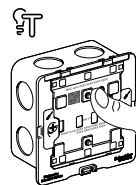
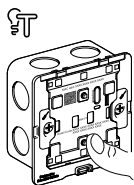
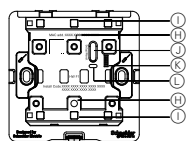
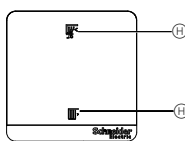
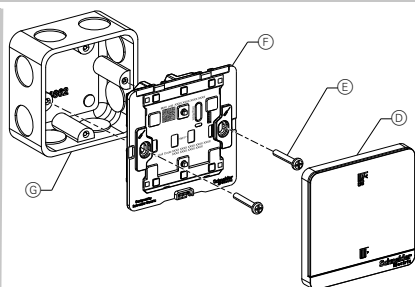
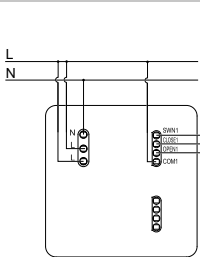
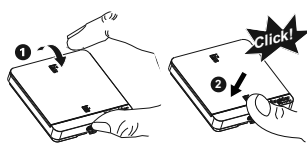
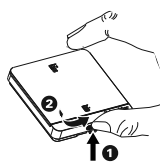
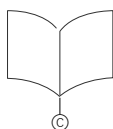
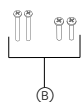
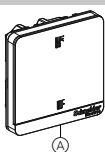

Flashing Orange    Flashing Red  
Green    Orange

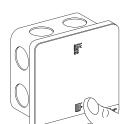

1x Short press (<1 s)



en

### Wiser AvatarOn 1G Curtain Switch

E8331SCN200ZB\_WE  
E8331SCN200ZB\_WG

#### For your safety

#### ⚠️ DANGER

#### RISK OF ELECTRIC SHOCK, EXPLOSION OR ARC FLASH

- This product must only be installed and serviced by appropriately qualified and/or licenced electrical personnel.
- This product must only be used for the purpose described in these instructions and must be installed in accordance with the wiring rules and regulations in that location.
- Observe the regulations while working on live parts.
- Isolate the electrical supply before doing any work on this product.
- Ensure that the product has been correctly installed and tested for safe operation before reconnecting the electrical supply.

Failure to follow these instructions will result in death or serious injury.

#### Prerequisites

Scan the QR code to download the Wiser by SE app onto your smartphone to configure and control the Wiser Zigbee devices.



App Store URL:  
<https://itunes.apple.com/us/app/wiser-by-se/id1026806919?ls=1&mt=8>



Google Play Store URL:  
<https://play.google.com/store/apps/details?id=com.schneiderelectric.WiserBySE>

#### Getting to know the product

The Wiser AvatarOn 1G Curtain Switch (the device) is used to control the specified motorized loads. The device is actuated either from the Wiser by SE app or Wiser AvatarOn Freelocate or by directly pressing the local control button.

- This device supports another type of motorized loads. Refer to the System user guide for more information.
- The device must not be used to control safety relevant applications.

#### Package contents

- Wiser AvatarOn 1G Curtain Switch
- Screws: Quantity 2: M3.5 x 32 mm  
Quantity 2: M4.0 x 25 mm
- Installation instructions

#### Connection elements

- Cover plate    Module
  - Screws    Wall box
- The wall box is not included in the package.

#### Mounting the device

- To remove the cover plate, press the buckle at the bottom.
- To install the cover plate, insert the cover plate on the module and press until the buckle clicks.

#### Choosing the installing location

- Make sure there is sufficient depth (50 mm) on the wall to install the device.
- A standard 86 wall box must be used for installation.

#### Connecting the device

#### ⚠️ DANGER

#### RISK OF ELECTRIC SHOCK, EXPLOSION OR ARC FLASH

- When working on the device, always disconnect the device from the power supply, as the output may carry electrical current even when the load is switched off.
- Turn off the Miniature Circuit Breaker (MCB) before installation, maintenance, or service (or replacement of the load) of the device.

Failure to follow these instructions will result in death or serious injury.

- Make sure that the cover plate is removed from the device before installation.
- Do not install the device behind large metal objects, such as refrigerators, cabinets, or cupboards, as it will affect the wireless communication range and performance of the device.

#### ⚠️ DANGER

#### RISK OF ELECTRIC SHOCK, EXPLOSION OR ARC FLASH

Do not short the outputs to neutral.  
Failure to follow these instructions will result in death or serious injury.

#### ⚠️ CAUTION

**EQUIPMENT DAMAGE**  
Always operate the product in compliance with the specified technical data.  
Failure to follow these instructions can result in injury or equipment damage.

#### NOTICE

#### EQUIPMENT DAMAGE

Do not use the device to drive the AC curtain motor, which has a AC/DC convertor inside.  
Failure to follow these instructions can result in equipment damage.

#### Operating elements

- Local control button
- Backlight button indicator
- Setup/Reset button
- Programming port
- Programming indicator

#### Setting the device

##### Testing the device

After you install the device, test the basic functions and then install the cover plate. Short press the local control button for <1 s. The motorized loads of the corresponding channels turns on/off.

##### Commissioning the device

Short press the Setup/Reset button 3 times with a time interval of <1 s to connect to an available Zigbee network or to create a new Zigbee network. For more information, refer to the system user guide.

##### Resetting the device

Short press the Setup/Reset button 3 times with a time interval of <1 s and then long press the Setup/Reset button once for >10 s to reset the device to factory default mode.

Upon successful device reset, all configuration data, user data, and network data is deleted.

##### E-mode commissioning

E-mode system consists of Wiser AvatarOn Switches, Wiser AvatarOn Curtain Switches, Wiser AvatarOn Dimmers, and Wiser AvatarOn Freelocates.

After successful E-mode commissioning, you can remotely control the corresponding channels on the Wiser AvatarOn Switches, Wiser AvatarOn Curtain Switches, Wiser AvatarOn Dimmers with Wiser AvatarOn Freelocates. In E-mode commissioning, the Wiser AvatarOn Switches, Wiser AvatarOn Curtain Switches, and Wiser AvatarOn Dimmers can create a Zigbee network.

Refer to the system user guide for E-mode commissioning procedures.

#### Operating the device

You can control the corresponding channels on the Wiser AvatarOn Curtain Switches directly by pressing the local control button, or remotely through the Wiser by SE app or Wiser AvatarOn Freelocate.

#### Behaviour of the programming indicator

Refer to the system user guide.

#### Troubleshooting

Refer to the system user guide.

#### Technical data

Power rating	<p>If the power factor of the load is less than the number specified, the power rating of the device needs to be derated.</p>
Number of gang	1
Connector type	Brass terminal, Terminal block
Terminal capacity	1 x 2.5 mm <sup>2</sup> 2 x ≤ 1.5 mm <sup>2</sup>
Number of cables for terminal block	0.5 mm <sup>2</sup> to 1.5 mm <sup>2</sup> (26 AWG to 14 AWG), solid or stranded types 1 x 1.5 mm <sup>2</sup>
Max transmitted power	≤ 10 dBm
Frequency range	2400 MHz to 2483.5 MHz
IP rating	IP20
Operating temperature	-10 °C to 45 °C
Relative humidity	10% to 95%
Product dimensions (H x W x D)	86 x 86 x 38 mm
Wall box dimensions (H x W x D)	75 x 75 x 50 mm The wall box must have minimum 50 mm depth.
Standards	EN 60669-2-5 IEC 60669-2-5
Certifications	CE complaint Zigbee 3.0 compliant

#### Trademarks

- Zigbee® is a registered trademark of the Zigbee Alliance.
  - Apple® and App Store® are brand names or registered trademarks of Apple Inc.
  - Google Play™ Store and Android™ are brand names or registered trademarks of Google Inc.
- Other brands and registered trademarks are properties of their relevant owners.

#### Schneider Electric Asia Pacific Limited

11th Floor, Kerry Centre, 683 King's Road, Quarry Bay, Hong Kong  
[se.com/contact](http://se.com/contact)

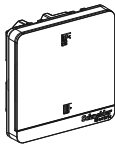

en zh



Wiser by SE app



E8331SCN200ZB\_WE  
E8331SCN200ZB\_WG

AvatarOn

Schneider Electric

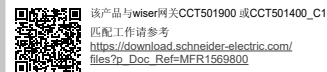

操作电压：220 VAC 至 240 VAC

200 W, 功率因数 = 0.6

操作电压：100 VAC 至 120 VAC

100 W, 功率因数 = 0.6

操作电压：48 VDC

40 W

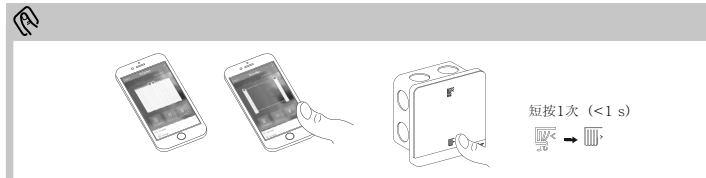
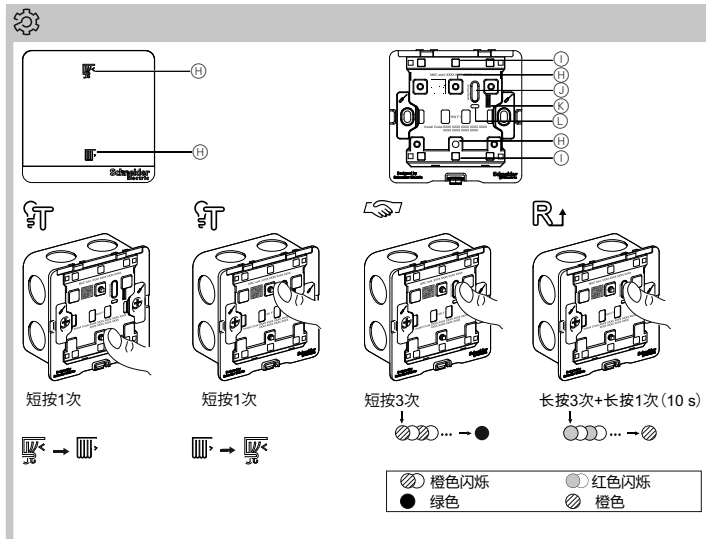
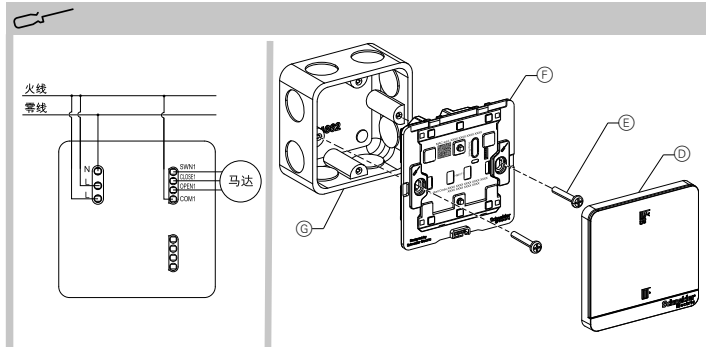
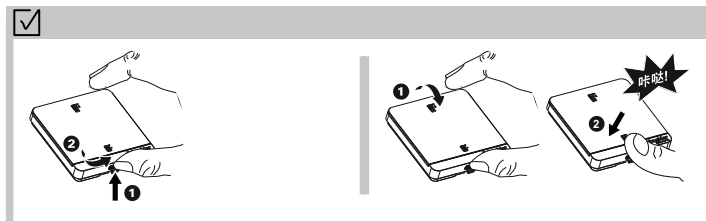
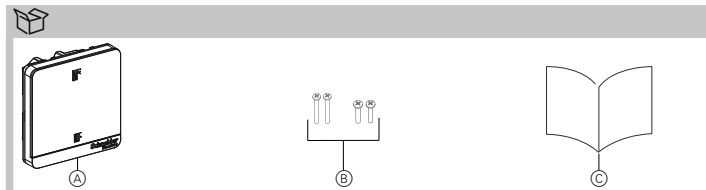

## 智能单联窗帘开关

E8331SCN200ZB\_WE  
E8331SCN200ZB\_WG

### 安全提示

#### 危险

##### 触电，爆炸或电弧闪光危险

- 本产品应仅由具有相应资质和/或获得相应证书的电气人员进行安装和维护。
- 本产品应仅用于本说明书中所述的用途，且必须根据接线规则和当地法规进行安装。
- 操作带电部件时请遵守相关规则。
- 对产品进行任何操作之前，务必切断电源。
- 重新连接电源之前，本产品必须正确安装且经过测试，确保操作的安全性。

若不遵守此说明，则可能会导致死亡或重伤。

### 前提条件

扫描二维码下载 Wiser by SE app 到您的智能手机，以配置和安装 Wiser Zigbee 设备



App Store 的 URL:  
<https://itunes.apple.com/us/app/wiser-by-se/id1026806919?ts=1&mt=8>



Android App 的 URL:  
<https://www.schneider-electric.cn/zh/product-range-download/65750-登高无线智能家居/#software-firmware-lab>

### 产品简介

智能单联窗帘开关（本设备）专用于控制指定的机动负载。该设备既可通过 Wiser by SE app 或智能场景开关来控制，也可直接通过按下本地控制按键来使用

- 此设备支持另一种类型的电机负载。更多信息，请参阅系统用户指南。
- 此设备不得用于控制安全相关的应用。

### 包装内容

- A 智能单联窗帘开关
- B 螺钉：2 颗：M3.5 × 32 mm 2 颗：M4.0 × 25 mm
- C 安装说明书

### 连接元件

- D 盖板
- E 螺钉
- F 模块
- G 墙盒

包装内不包含墙盒。

### 安装设备

#### 取下和安装盖板

- 要取下盖板，按下底部的扣位即可。
- 要安装盖板，请将盖板插入到设备中，并往下按，直至扣位发出咔嗒声。

#### 选择安装位置

- 墙体必须够深（50 mm），以安装此设备。
- 必须使用标准的 86 mm 墙盒箱进行安装。

#### 连接设备

#### 危险

##### 触电，爆炸或电弧闪光危险

- 当在设备上操作时，请务必断开设备电源连接，因为即使在负载关闭的情况下，在输出端也可能会有电流。
- 请在切断断路器（MCB）后再对设备执行安装，维护或维修（或负载更换）等操作。

若不遵守此说明，则可能会导致死亡或重伤。

- 盖板必须在安装前取下。
- 请勿将此设备安装在冰箱、橱柜或橱柜等大型金属物体背后，因为这会影响设备的无线通信范围和性能。

#### 危险

##### 触电，爆炸或电弧闪光危险

- 请勿缩短输出到中性线的距离。

若不遵守此说明，则可能会导致死亡或重伤。

#### 注意

- 设备损坏  
请始终根据指定的技术数据操作产品。
- 若不遵守此说明，则可能会导致人员受伤或设备损坏。

#### 注意

- 设备损坏  
请勿将此设备用于驱动内置有 AC/DC 变频器的 AC 窗帘电机。
- 若不遵守此说明，则可能会导致设备损坏。

### 操作元件

- H 本地控制按键
- I 背光按键指示灯
- J Setup/Reset 按键
- K 编程端口
- L 编程指示灯

### 设置设备

- 测试设备  
设备安装成功后，请对其基本功能进行测试，然后安装盖板。快速按下本地控制按键，（时长：<1 s）间。相应通

道的机动负载会关闭或打开。

### 调试设备

快速按下 Setup/Reset 按钮 3 次，时间间隔 <1 s，以连接到可用的 Zigbee 网络，或是创建一个 Zigbee 网络。更多信息，请参阅系统用户指南。

### 重置设备

快速按 Setup/Reset 按钮 3 次，时间间隔 <1 s，随后，长按 Setup/Reset 按钮一次（时长 >10 s），即可将设备重置为出厂默认模式。

设备重置成功后，所有配置数据，用户数据和网络数据均被删除。

### 简单模式调试

简单模式调试系统由智能开关，智能窗帘开关，智能调光开关和智能场景开关组成。

简单模式调试成功后，即可对智能开关，智能窗帘开关，智能调光开关，智能场景开关上的相应通道实施远程控制。在进行简单模式试期间，智能开关，智能窗帘开关和智能调光开关可创建一个 Zigbee 网络。

有关简单模式调试流程，请参阅系统用户指南。

### 操作设备

可以通过 Wiser by SE app 或智能场景开关对智能场景开关上的相应通道进行远程控制。

### 编程指示灯的行为

请参阅系统用户指南。

### 故障排除

请参阅系统用户指南。

### 技术参数

额定功率	如果负载的功率因数小于指定的数值，则需要降低设备的额定功率。
负载通道数	1
连接端类型	黄铜端子，接线盒
终端容量	1 × 2.5 mm <sup>2</sup> 2 × ≤ 1.5 mm <sup>2</sup>
用于接线盒的电缆数量	0.5 mm <sup>2</sup> - 1.5 mm <sup>2</sup> (26 AWG - 14 AWG), 实心线或绞线类型 1 × 1.5 mm <sup>2</sup>
最大传输功率	≤ 10 dBm
频率范围	2400 MHz - 2483.5 MHz
IP 等级	IP20
工作温度	-10 °C - +45 °C
相对湿度	10% - 95%
产品尺寸 (H × W × D)	86 × 86 × 38 mm
墙盒尺寸 (H × W × D)	75 × 75 × 50 mm 墙盒的深度至少为 50 mm。
标准	符合 EN 60669-2-5 标准 符合 IEC 60669-2-5 标准
认证	符合 CE 标准 符合 Zigbee 3.0 标准

部件名称 Part Name	有害物质				
	铅 Pb	汞 Hg	镉 Cd	六价铬 Cr(VI)	多溴联苯 PBB 多溴二苯醚 PBDE
金属件 Metal parts	x	o	o	o	o
塑胶件 Plastic parts	o	o	o	o	o
电子件 Electronic	x	o	o	o	o
触点 Contacts	o	o	o	o	o
线缆和线缆附件 Cables and cabling accessories	o	o	o	o	o

本表格依据 SJ/T11364 的规定编制。  
o: 表示该有害物质在该部件所有均质材料中的含量均在 GB/T 26572 规定的限量要求以下。  
x: 表示该有害物质至少在该部件的某一均质材料中的含量超出 GB/T 26572 规定的限量要求。

This table is made according to SJ/T 11364.  
o: indicates that the concentration of hazardous substance in all of the homogeneous materials for this part is below the limit as stipulated in GB/T 26572.  
x: indicates that concentration of hazardous substance in at least one of the homogeneous materials used for this part is above the limit as stipulated in GB/T 26572.

商标  
• Zigbee® 是 Zigbee Alliance 的注册商标。  
• Apple® 和 App Store® 是 Apple Inc. 的品牌名称或注册商标。  
• Android™ 是 Google Inc. 的品牌名称或注册商标。  
所有其他商标和注册商标均为其各自所有者的财产。

### 施耐德电气(中国)有限公司

北京市朝阳区望京东路六号A座  
客户支持热线: 400 810 1315  
se.com/contact